

MANIFOLD FITTINGS



For over 60 years OTECO, Inc. has been providing high quality oilfield equipment to the worldwide oil and gas markets.

Operating from our modern 120,000 square foot manufacturing facility in Houston, Texas, OTECO continues to provide products to the high quality standards for which we are known.



<http://www.OTECO.com>



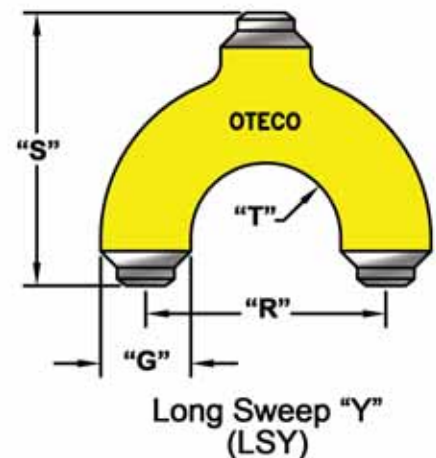
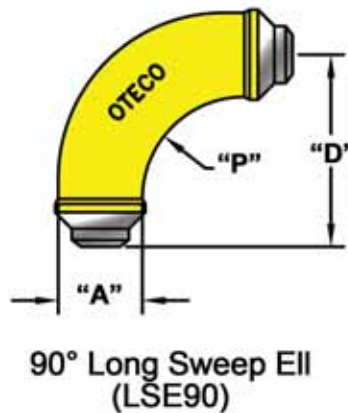
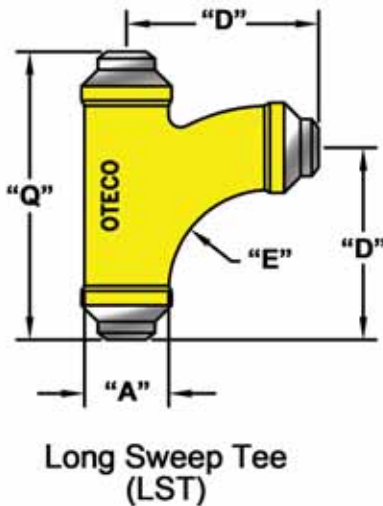
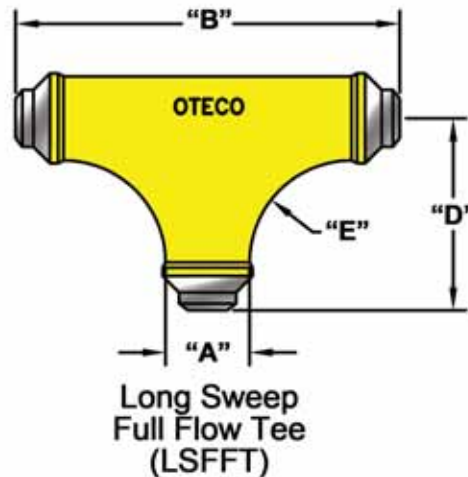
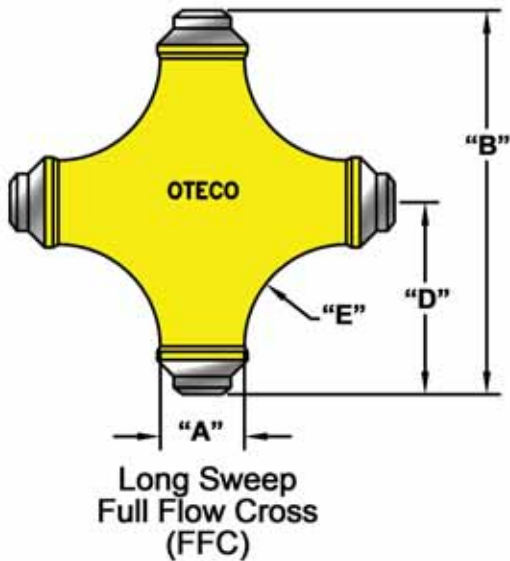

DIMENSION CHART

FFC, LSFFT, LST, LSE45, LSE90, LSY

	"A"	"B"	"D"	"E"	"G"	"K"	"L"	"P"	"Q"
Inches	3.50	16.00	8.00	4.25	3.75	2.50	4.25	4.13	12.00
mm	88.9	406.4	203.2	108.0	95.3	63.5	108.0	104.9	304.8

	"R"	"S"	"T"
Inches	10.00	11.38	3.13
mm	254.0	289.1	79.5

Note: On butt weld fittings, the weld bevel is 37.5°. The O.D. and the I.D. of the weld end fittings match ANSI B36.10. Dimensions are applicable to both weld end and screwed end fittings.

Item #	2" Manifold Description	Max. Press. PSI (BAR)	Weight Lbs.
412101	FULL FLOW CROSS,2222X,2" LPT	5,000 (345)	110
412103	FULL FLOW CROSS,2222X,2" BW SCH.160	5,000 (345)	110
412104	FULL FLOW CROSS,2222X,2" BW SCH.XXS	5,000 (345)	110
412071	LONG SWEEP ELL,22L45,2" LPT	5,000 (345)	12
412073	LONG SWEEP ELL,22L45,2" BW SCH.160	5,000 (345)	12
412074	LONG SWEEP ELL,22L45,2" BW SCH.XXS	5,000 (345)	12
412061	LONG SWEEP ELL,22L90,2" LPT	5,000 (345)	30
412015	LONG SWEEP ELL,22L90,2" BW SCH.80	3,000 (207)	30
412063	LONG SWEEP ELL,22L90,2" BW SCH.160	5,000 (345)	30
412064	LONG SWEEP ELL,22L90,2" BW SCH.XXS	5,000 (345)	30
412011	LONG SWEEP FULL FLOW TEE,222T,2" LPT	5,000 (345)	51
412016	LONG SWEEP FULL FLOW TEE,222T,2" BW SCH.80	3,000 (207)	51
412013	LONG SWEEP FULL FLOW TEE,222T,2" BW SCH.160	5,000 (345)	51
412014	LONG SWEEP FULL FLOW TEE,222T,2" BW SCH.XXS	5,000 (345)	51
412021	LONG SWEEP TEE,222LST,2" LPT	5,000 (345)	60
412023	LONG SWEEP TEE,222LST,2" BW SCH.160	5,000 (345)	60
412024	LONG SWEEP TEE,222LST,2" BW SCH.XXS	5,000 (345)	60
412091	LONG SWEEP Y,222Y,2" LPT	5,000 (345)	51
412093	LONG SWEEP Y,222Y,2" BW SCH.160	5,000 (345)	51
412094	LONG SWEEP Y,222Y,2" BW SCH.XXS	5,000 (345)	51

Note: Sour gas service available.

Castings are made from ASTM A216 Grade WCC.

Special end connections available upon request.

Sch.80 end connections rated at 3K PSI working pressure.

Material tensile and chemical properties available upon request.

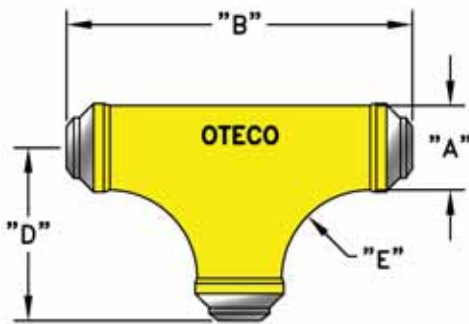

Long Sweep
Full Flow Tee
(LSFFT)

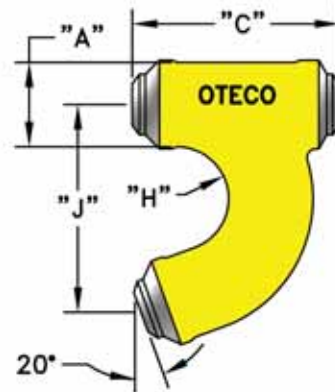

160° Standpipe Gooseneck
with Top Outlet
(GSNKTO)

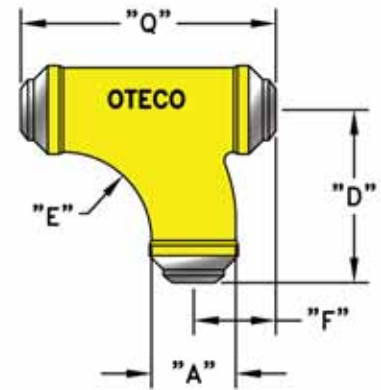

Long Sweep Tee
(LST)

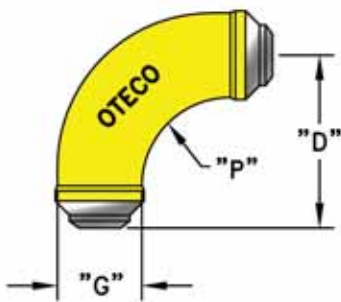

90° Long Sweep Ell
(LSE90)

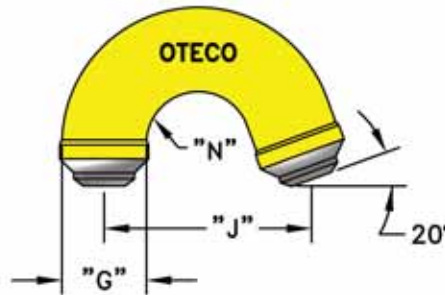

160° Standpipe
Gooseneck
(GSNK160)

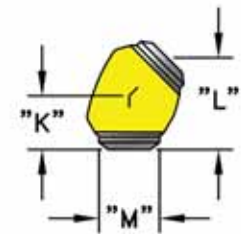

45° Long Sweep Ell
(LSE45)

DIMENSION CHART

LSFFT, GSNKTO, LST, LSE90, GSNK160, LSE45

	"A"	"B"	"C"	"D"	"E"	"F"	"G"	"H"	"J"
Inches	4.88	20.00	12.00	10.00	5.13	4.75	5.13	3.01	12.00
mm	124.0	508.0	304.8	254.0	130.3	120.7	130.3	76.5	304.8

	"K"	"L"	"M"	"N"	"P"	"Q"
Inches	3.11	5.31	5.06	2.89	5.00	14.75
mm	79.0	134.9	128.5	73.4	127.0	374.7

Note: On butt weld fittings, the weld bevel is 37.5°. The O.D. and the I.D. of the weld end fittings match ANSI B36.10. Dimensions are applicable to both weld end and screwed end fittings.

Item #	3" Manifold Description	Max. Press. PSI (BAR)	Weight Lbs.
413051	GOOSENECK 160° W/TOP OUTLET,333GTO,3" LPT	3,000 (207)	105
413053	GOOSENECK 160° W/TOP OUTLET,333GTO,3" BW SCH.160	5,000 (345)	105
413054	GOOSENECK 160° W/TOP OUTLET,333GTO,3" BW SCH.XXS	5,000 (345)	105
413031	GOOSENECK 160°,33G6,3" LPT	3,000 (207)	82
413033	GOOSENECK 160°,33G6,3" BW SCH.160	5,000 (345)	82
413034	GOOSENECK 160°,33G6,3" BW SCH.XXS	5,000 (345)	82
413071	LONG SWEEP ELL,33L45,3" LPT	3,000 (207)	20
413073	LONG SWEEP ELL,33L45,3" BW SCH.160	5,000 (345)	20
413074	LONG SWEEP ELL,33L45,3" BW SCH.XXS	5,000 (345)	20
413061	LONG SWEEP ELL,33L90,3" LPT	3,000 (207)	67
413063	LONG SWEEP ELL,33L90,3" BW SCH.160	5,000 (345)	67
413064	LONG SWEEP ELL,33L90,3" BW SCH.XXS	5,000 (345)	67
413011	LONG SWEEP FULL FLOW TEE,333T,3" LPT	3,000 (207)	97
413013	LONG SWEEP FULL FLOW TEE,333T,3" BW SCH.160	5,000 (345)	97
413014	LONG SWEEP FULL FLOW TEE,333T,3" BW SCH.XXS	5,000 (345)	97
413021	LONG SWEEP TEE,333LST,3" LPT	3,000 (207)	80
413023	LONG SWEEP TEE,333LST,3" BW SCH.160	5,000 (345)	80
413024	LONG SWEEP TEE,333LST,3" BW SCH.XXS	5,000 (345)	80

Note: Sour gas service available.

Castings are made from ASTM A216 Grade WCC.

Special end connections available upon request.

Sch.80 B.W. & 3" L.P.T. end connections rated at 3K PSI working pressure.

Material tensile and chemical properties available upon request.

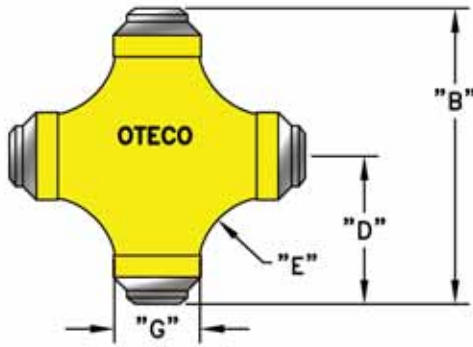
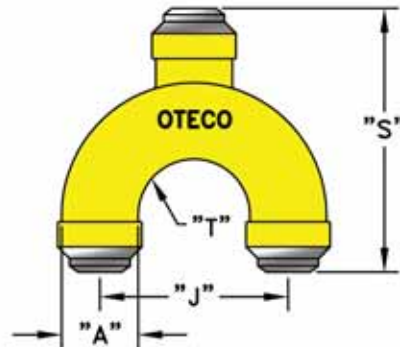
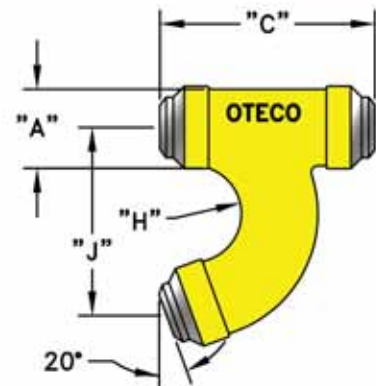
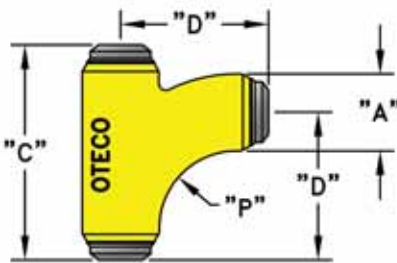
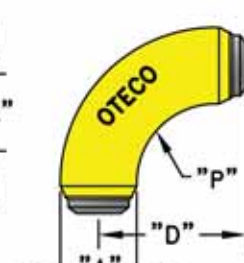
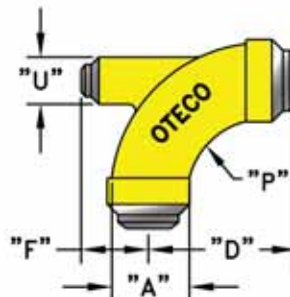
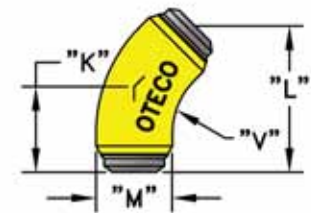
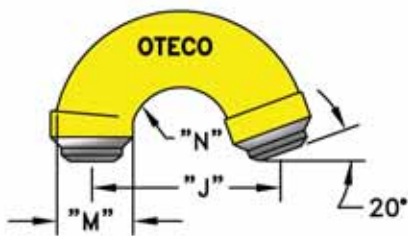
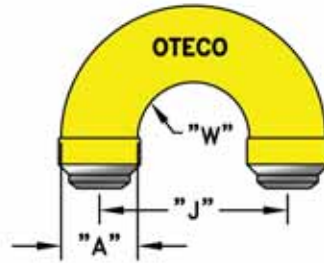
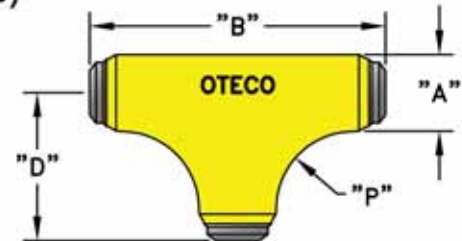
Full Flow Cross
(FFC)Long Sweep "Y"
(LSY)160° Standpipe Gooseneck
with Top Outlet
(GSNKTO)Long Sweep Tee
(LST)90° Long Sweep Ell
(LSE90)90° Long Sweep Ell
with 2" Outlet
(424LSE90)45° Long Sweep Ell
(LSE45)160° Standpipe
Gooseneck
(GSNK160)180° Standpipe
Gooseneck
(GSNK180)Long Sweep
Full Flow Tee
(LSFFT)

DIMENSION CHART

FFC, LSY, GSNKTO, LST, LSE90, 424LSE90, LSE45, GSNK160, GSNK180, LSFFT

	"A"	"B"	"C"	"D"	"E"	"F"	"G"	"H"	"J"	"K"
Inches	5.69	22.00	16.00	11.00	5.50	5.00	6.25	3.59	14.00	6.38
mm	144.5	558.8	406.4	279.4	139.7	127.0	158.8	91.2	355.6	162.1

	"L"	"M"	"N"	"P"	"S"	"T"	"U"	"V"	"W"
Inches	10.88	5.66	3.63	5.75	19.63	4.16	3.50	5.38	4.03
mm	276.4	143.8	92.2	146.1	498.6	105.7	88.9	136.7	102.4

Note: On butt weld fittings, the weld bevel is 37.5°. The O.D. and the I.D. of the weld end fittings match ANSI B36.10. Dimensions are applicable to both weld end and screwed end fittings.

Item #	4" Manifold Description	Max. Press. PSI (BAR)	Weight Lbs.
414101	FULL FLOW CROSS 4444X,4" LPT	3,000 (207)	206
414103	FULL FLOW CROSS 4444X,4" BW SCH.160	5,000 (345)	206
414104	FULL FLOW CROSS 4444X,4" BW SCH.XXS	5,000 (345)	206
414051	GOOSENECK 160° W/TOP OUTLET,444GTO,4" LPT	3,000 (207)	142
414053	GOOSENECK 160° W/TOP OUTLET,444GTO,4" BW SCH.160	5,000 (345)	142
414054	GOOSENECK 160° W/TOP OUTLET,444GTO,4" BWSCH.XXS	5,000 (345)	142
414031	GOOSENECK 160°,44G6,4" LPT	3,000 (207)	109
414033	GOOSENECK 160°,44G6,4" BW SCH.160	5,000 (345)	109
414034	GOOSENECK 160°,44G6,4" BW SCH.XXS	5,000 (345)	109
414041	GOOSENECK 180°,44G8,4" LPT	3,000 (207)	129
414043	GOOSENECK 180°,44G8,4" BW SCH.160	5,000 (345)	129
414044	GOOSENECK 180°,44G8,4" BW SCH.XXS	5,000 (345)	129
414081	LONG SWEEP ELL W/2" TOP OUTLET,424L90,4X2X4 LPT	3,000 (207)	95
414083	LONG SWEEP ELL W/2" TOP OUTLET,424L90,4" BW SCH.160	5,000 (345)	95
414084	LONG SWEEP ELL W/2" TOP OUTLET,424L90,4" BW SCH.XXS	5,000 (345)	95
414071	LONG SWEEP ELL,44L45,4" LPT	3,000 (207)	55
414073	LONG SWEEP ELL,44L45,4" BW SCH.160	5,000 (345)	55
414074	LONG SWEEP ELL,44L45,4" BW SCH.XXS	5,000 (345)	55
414061	LONG SWEEP ELL,44L90,4" LPT	3,000 (207)	87
414062	LONG SWEEP ELL,44L90,4" BW SCH.80	3,000 (207)	87
414063	LONG SWEEP ELL,44L90,4" BW SCH.160	5,000 (345)	87
414064	LONG SWEEP ELL,44L90,4" BW SCH.XXS	5,000 (345)	87
414011	LONG SWEEP FULL FLOW TEE,444T,4" LPT	3,000 (207)	140
414013	LONG SWEEP FULL FLOW TEE,444T,4" BW SCH.160	5,000 (345)	140
414014	LONG SWEEP FULL FLOW TEE,444T,4" BW SCH.XXS	5,000 (345)	140
414021	LONG SWEEP TEE,444LST,4" LPT	3,000 (207)	115
414023	LONG SWEEP TEE,444LST,4" BW SCH.160	5,000 (345)	115
414024	LONG SWEEP TEE,444LST,4" BW SCH.XXS	5,000 (345)	115
414091	LONG SWEEP Y,444Y,4" LPT	3,000 (207)	162
414093	LONG SWEEP Y,444Y,4" BW SCH.160	5,000 (345)	162
414094	LONG SWEEP Y,444Y,4" BW SCH.XXS	5,000 (345)	162

Note: Sour gas service available.

Castings are made from ASTM A216 Grade WCC.

Special end connections available upon request.

Sch.80 B.W. & 4" L.P.T. end connections rated at 3K PSI working pressure.

Material tensile and chemical properties available upon request.



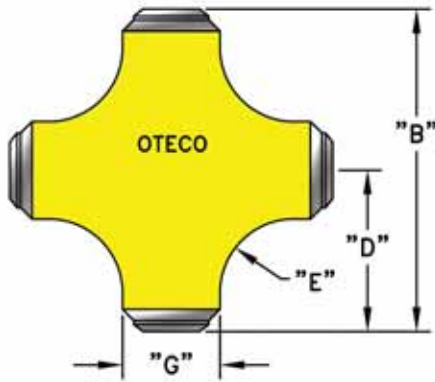

Full Flow Cross (FFC)

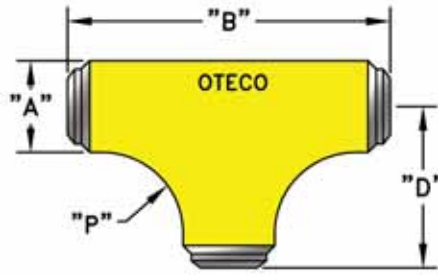

Long Sweep Full Flow Tee (LSFFT)

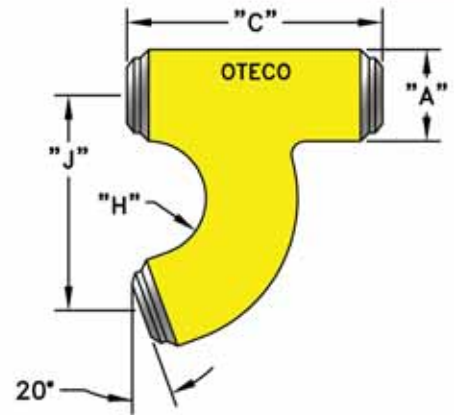

160° Standpipe Gooseneck with Top Outlet (GSNKTO)

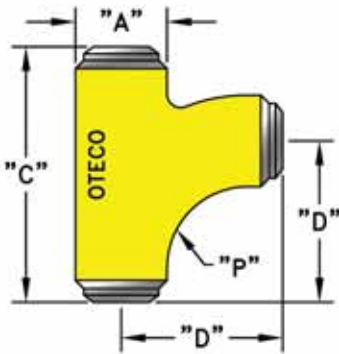

Long Sweep Tee (LST)

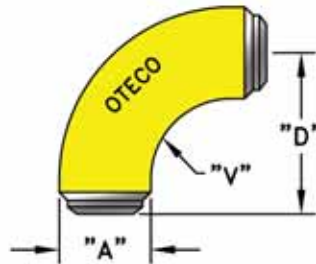

90° Long Sweep Ell (LSE90)



90° Long Sweep Ell with 2" Outlet (424LSE90)

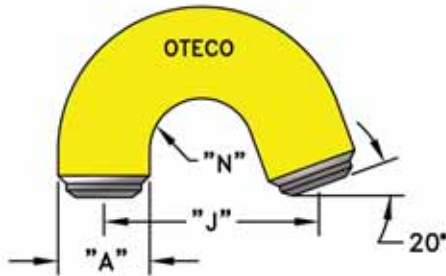

160° Standpipe Gooseneck (GSNK160)

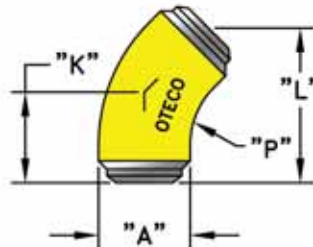

45° Long Sweep Ell (LSE45)

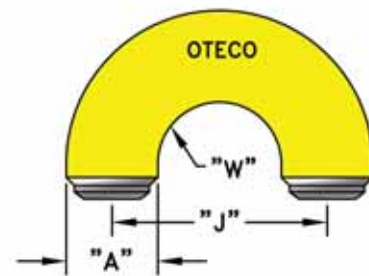

180° Standpipe Gooseneck (GSNK180)

DIMENSION CHART

FFC, LSFFT, GSNKTO, LST, LSE90, 525LSE90, LSE45, GSNK160, GSNK180

	"A"	"B"	"C"	"D"	"E"	"F"	"G"	"H"
Inches	6.81	24.00	19.00	12.00	5.50	7.00	7.25	4.25
mm	173.0	609.6	482.6	304.8	139.7	177.8	184.2	108.0
	"J"	"K"	"L"	"N"	"P"	"U"	"V"	"W"
Inches	16.00	6.74	11.50	3.75	6.00	3.50	5.88	4.47
mm	406.4	171.2	292.1	95.3	152.4	88.9	149.4	113.5

Note: On butt weld fittings, the weld bevel is 37.5°. The O.D. and the I.D. of the weld end fittings match ANSI B36.10. Dimensions are applicable to both weld end and screwed end fittings.

Item #	5" Manifold Description	Max. Press. PSI (BAR)	Weight Lbs.
415103	FULL FLOW CROSS,5555X,5" BW SCH.160	5,000 (345)	515
415104	FULL FLOW CROSS,5555X,5" BW SCH.XXS	5,000 (345)	515
417035	FULL FLOW CROSS,5555X,5" BW SCH.XXS	7,500 (517)	515
415053	GOOSENECK 160" W/TOP OUTLET,555GTO,5" BW SCH.160	5,000 (345)	220
415054	GOOSENECK 160" W/TOP OUTLET,555GTO,5" BW SCH.XXS	5,000 (345)	220
417055	GOOSENECK 160" W/TOP OUTLET,555GTO,5" BW SCH.XXS	7,500 (517)	220
415033	GOOSENECK 160",55G6,5" BW SCH.160	5,000 (345)	200
415034	GOOSENECK 160",55G6,5" BW SCH.XXS	5,000 (345)	200
415043	GOOSENECK 180",55G8,5" BW SCH.160	5,000 (345)	220
415044	GOOSENECK 180",55G8,5" BW SCH.XXS	5,000 (345)	220
415083	LONG SWEEP ELL W/2" TOP OUTLET,525L90,5" BW SCH.160	5,000 (345)	140
415084	LONG SWEEP ELL W/2" TOP OUTLET,525L90,5" BW SCH.XXS	5,000 (345)	140
415073	LONG SWEEP ELL,55L45,5" BW SCH.160	5,000 (345)	74
415074	LONG SWEEP ELL,55L45,5" BW SCH.XXS	5,000 (345)	74
417045	LONG SWEEP ELL,55L45,5" BW SCH.XXS	7,500 (517)	74
415063	LONG SWEEP ELL,55L90,5" BW SCH.160	5,000 (345)	116
415064	LONG SWEEP ELL,55L90,5" BW SCH.XXS	5,000 (345)	116
417005	LONG SWEEP ELL,55L90,5" BW SCH.XXS	7,500 (517)	116
415013	LONG SWEEP FULL FLOW TEE,555T,5" BW SCH.160	5,000 (345)	200
415014	LONG SWEEP FULL FLOW TEE,555T,5" BW SCH.XXS	5,000 (345)	200
417025	LONG SWEEP FULL FLOW TEE,555T,5" BW SCH.XXS	7,500 (517)	200
415023	LONG SWEEP TEE,555LST,5" BW SCH.160	5,000 (345)	161
415024	LONG SWEEP TEE,555LST,5" BW SCH.XXS	5,000 (345)	161
417015	LONG SWEEP TEE,555LST,5" BW SCH.XXS	7,500 (517)	161

Note: Sour gas service available.

5K Castings are made from ASTM A216 Grade WCC.

7.5K Castings are made from ASTM A487 Grade 4D Modified.

Special end connections available upon request.

Material tensile and chemical properties available upon request.

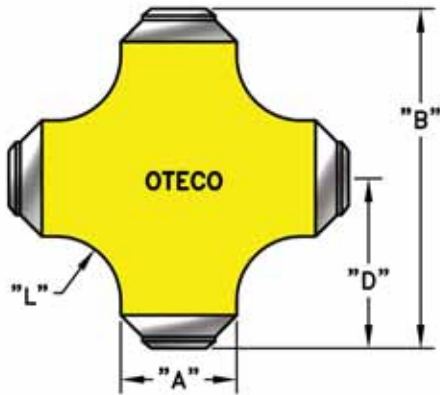

Full Flow Cross (FFC)

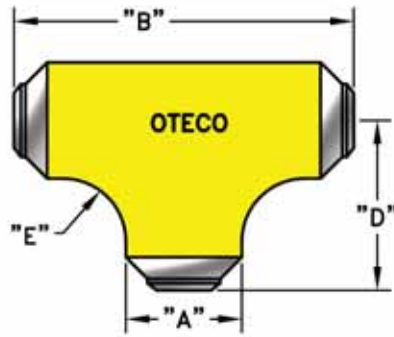

Long Sweep Full Flow Tee (LSFFT)

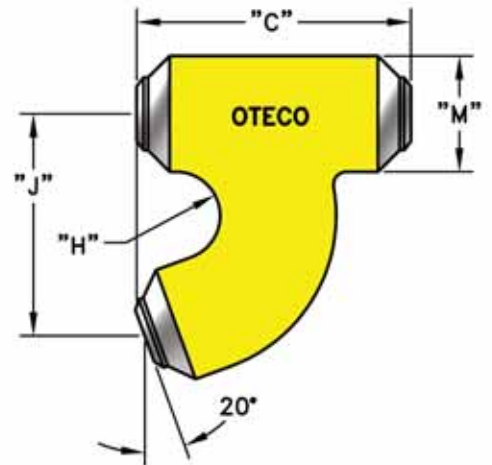

160° Standpipe Gooseneck with Top Outlet (GSNKTO)

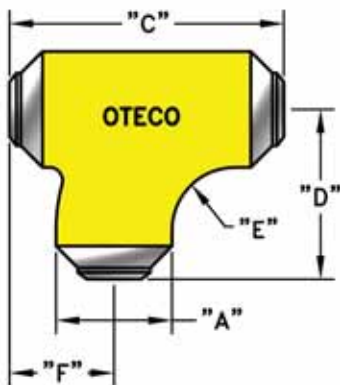

Long Sweep Tee (LST)

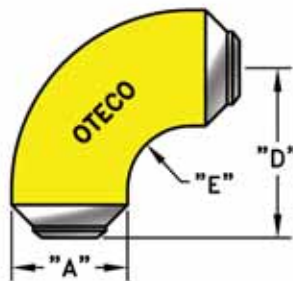

90° Long Sweep Ell (LSE90)

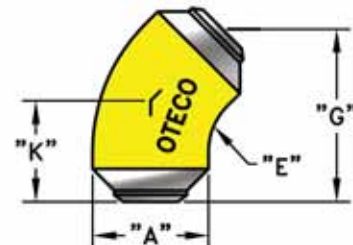

45° Long Sweep Ell (LSE45)

DIMENSION CHART

FFC, LSFFT, GSNKTO, LST, LSE90, LSE45

	"A"	"B"	"C"	"D"	"E"	"F"	"G"	"H"
Inches	8.88	26.00	21.00	13.00	4.81	8.00	13.25	3.19
mm	225.6	660.4	533.4	330.2	122.2	203.2	336.6	81.0

	"J"	"K"	"L"	"M"
Inches	17.00	7.75	4.94	9.25
mm	431.8	196.9	125.5	235.0

Note: On butt weld fittings, the weld bevel is 37.5°. The O.D. and the I.D. of the weld end fittings match ANSI B36.10. Dimensions are applicable to both weld end and screwed end fittings.

Item #	5" 8K Extra Heavy Wall Manifold Description	Max. Press. PSI (BAR)	Weight Lbs.
418035	FULL FLOW CROSS,5555X,5" BW SCH.XXS	8,000 (552)	581
418055	GOOSENECK 160" W/TOP OUTLET,555GTO,5" BW SCH.XXS	8,000 (552)	435
418045	LONG SWEEP ELL,55L45,5" BW SCH.XXS	8,000 (552)	203
418005	LONG SWEEP ELL,55L90,5" BW SCH.XXS	8,000 (552)	352
418025	LONG SWEEP FULL FLOW TEE,555T,5" BW SCH.XXS	8,000 (552)	436
418015	LONG SWEEP TEE,555LST,5" BW SCH.XXS	8,000 (552)	314

Item #	6" 8K Manifold Description	Max. Press. PSI (BAR)	Weight Lbs.
-----	6" Buttweld ends available upon request	8,000 (552)	---

Note: Sour gas service available.

Castings are made from ASTM A487 Grade 4D Modified.

Special end connections available upon request in Sch.XXS only.

Material tensile and chemical properties available upon request.

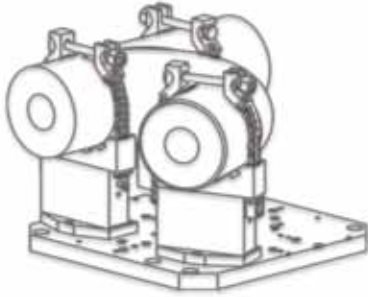

Most manifold fittings are machined to exceptional tolerances using single chucking on horizontal machining centers.

Buttweld and screwed API line pipe connections are available in 2 inch, 3 inch and 4 inch sizes. Five inch and six inch are available with buttweld connections.

Special end connections such as socketweld and metric values available upon request.

All fittings are hydrostatically tested to a minimum of 1-1/2 times working pressure.

See chart below for values.

**MAXIMUM WORKING & TEST PRESSURES
FOR FITTINGS PSI (BAR)**

NOMINAL PIPE SIZE	SCH. 40		SCH. 80		SCH. 120		SCH. 160		SCH. XXS	
	W.P.	T.P.	W.P.	T.P.	W.P.	T.P.	W.P.	T.P.	W.P.	T.P.
2"	2,000 (138)	4,000 (276)	3,000 (207)	6,000 (414)			5,000 (345)	7,500 (517)	5,000 (345)	10,000 (689)
3"	2,000 (138)	4,000 (276)	3,000 (207)	6,000 (414)			5,000 (345)	7,500 (517)	5,000 (345)	10,000 (689)
4"	2,000 (138)	3,000 (207)	3,000 (207)	4,500 (310)	4,000 (276)	6,000 (414)	5,000 (345)	7,500 (517)	5,000 (345)	10,000 (689)
5"	2,000 (138)	3,000 (207)	3,000 (207)	4,500 (310)	4,000 (276)	6,000 (414)	5,000 (345)	7,500 (517)	5,000 (345)	10,000 (689)
5" 7.5K									7,500 (517)	11,250 (776)
5" 8K EHW	HIGH PRESSURE MANIFOLD FITTINGS MADE FOR SCH.XXS ONLY								8,000 (552)	12,000 (827)
6" 8K									8,000 (552)	12,000 (827)

A.P.I. L.P.T.	2"	3"	4"	5"
W.P.	5,000 (345)	3,000 (207)	3,000 (207)	N/A
T.P.	10,000 (689)	6,000 (414)	6,000 (414)	N/A

OTECO, Inc.



2828 Trout St.
Houston, Texas 77093-5546
Phone: 713-695-3693
Fax: 713-695-3520

Web Address: <http://www.OTECO.com>
E-mail: Sales@OTECO.com

